

Please note that the data given here has been taken from the online catalog. For comprehensive information and data, please refer to the user documentation at <http://www.download.phoenixcontact.com>. The General Terms and Conditions of Use apply to Internet downloads.

► Extract from the online catalog

Headers, 3.5 mm pitch, color: black, plug-in direction vertical to the PCB

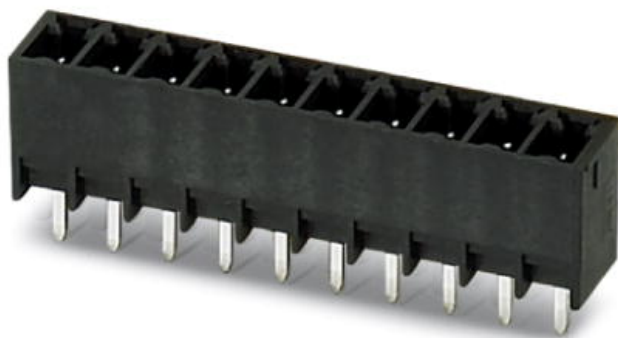

The figure shows a 10-position version of the product

Order No.	1937622
Ord designation	MCV 1,5/ 4-G-3,5 THT

EAN	4017918890278
Pack	50 Pcs.
Customs tariff	85366990
Weight/Piece	0.0023 KG
Catalog page information	Page 139 (CC-2007)

► Product notes

WEEE/RoHS-compliant since: 01/01/2003



IMPORTANT : This date is valid for Customers in Germany only. Date Format is MM/DD/YYYY. Please contact your local in-country Phoenix Contact location or designated business partner for a Logistics Compliant date in your area. In order to guarantee delivery of RoHS-Compliant product, please purchase Phoenix Contact parts from authorized Phoenix Contact representatives and distributors.

MCV 1,5/ 4-G-3,5 THT



▶ **Technical data**

Dimensions / positions

Pitch	3.5 mm
Dimension a	10.5 mm
Number of positions	4
Pin dimensions	0,8 x 0,8 mm
Hole diameter	1.4 mm

Technical data

Insulating material group	IIIa
Rated surge voltage (III/3)	2.5 kV
Rated surge voltage (III/2)	2.5 kV
Rated surge voltage (II/2)	2.5 kV
Rated voltage (III/2)	160 V
Rated voltage (II/2)	320 V
Connection in acc. with standard	EN-VDE
Nominal current I_N	8 A
Nominal voltage U_N	160 V
Maximum load current	8 A (per position)
Insulating material	PA-F
Inflammability class acc. to UL 94	V0

Drawings

Application drawing

The Steps for the "PIN-in-Paste" Procedure

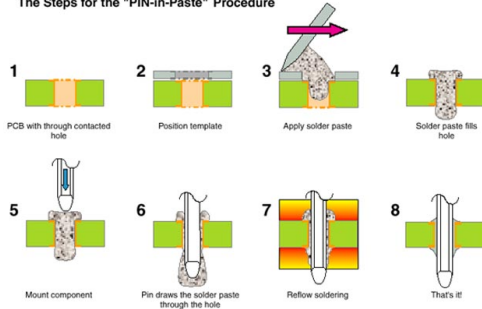

Tips and Recommendations for Users

Hole and Pad Dimensions/Pin Geometries

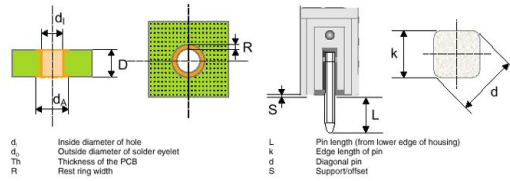

	Actual dimensions	Recommendations
MINI COMBICON	$d = 1,15 \text{ mm}$ $k = 0,8 \text{ mm}$ $S = 0,3 \text{ mm}$	$d_i = 1,3 \text{ mm}^{1)}$ $R = 0,5 \text{ mm}^{2)}$

¹⁾ Hole diameter acc. to DIN IEC 60 352-5 and taking into account the mounting accuracy of automatic mounting machines.
²⁾ The recommended rest ring width of 0.5 mm refers to case II/2 on the PCB (surge voltage category/contamination class) assuming a rated voltage of 160 V (MC 1.5) for the component. When the rest ring width is determined, the requirements for air and creepage distances acc. to the respective equipment standards must be taken into account; smaller rest ring widths or other pad geometries must be used if necessary.

Applying Solder Paste

It is assumed that a conventional template print procedure is used when applying the solder paste.

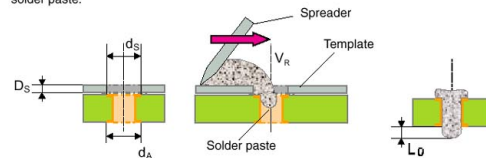

- d_o Outside diameter of solder eyelet
 - d_i Inside diameter of hole -0.1 mm
 - Th Template thickness = recommended thickness of template 150 μm
 - V_s Spreader speed = 30-150 mm/sec.)
 - S_o Solder paste overhang = up to 1/2 printed circuit board thickness
- ¹⁾ Speed of spreader and pressure depend on the type of screen printer and the solder paste; e.g. Sn 62 Pb 36 Ag 2 with 20-40 μm grain (V_S = approx. 50 mm/sec).

Reference Profile for Reflow-Solder Processes

A temperature profile based on EN 61 760-1 is recommended:

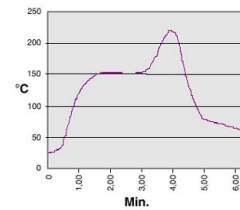

- Parameters/Settings:
- Creating temperature profile: Preferably with forced convection or vapor phase furnace.
 - The use of infra-red radiation should be avoided if possible.
 - Maximum temperature/time ranges: 215 °C for 30 seconds and 230 °C for 15 seconds.
 - Profiles with temperature loads that last considerably longer than 4.5 min. until the peak temperatures are reached should be avoided.
 - The whole profile cycle should take approx. 5 min.
 - Pre-heating to achieve even heating up of the components: 210 to 240 sec.
 - Cooling down phase: min. 4°C/sec.

Drilling diagram

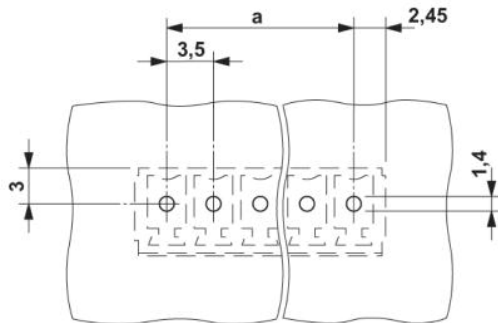

Dimensioned drawing

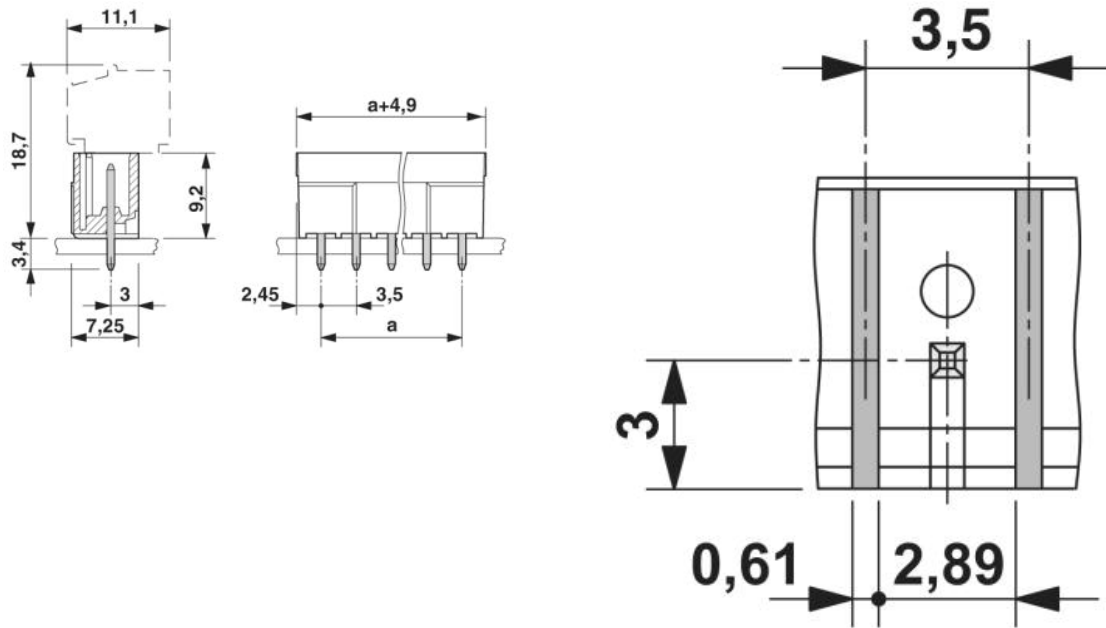

► Address

PHOENIX CONTACT GmbH & Co. KG
Flachsmarktstr. 8
32825 Blomberg
Germany
Phone +49 5235 3 00
Fax +49 5235 3 41200
<http://www.phoenixcontact.de>
Phoenix Contact
Technical modifications reserved;